

**HEATPEX**

> [heatpex.pl](http://heatpex.pl)

**ARIA**

**ONE**<sup>®</sup>  
CLICK  
technology

HEAT RECOVERY VENTILATION



NEW  
SYSTEM  
**90**  
mm



MVHR AIR  
DISTRIBUTION  
DUCTING  
SYSTEM

**ARIA**  
ADURO

INSULATED MASS  
FLOW DUCTWORK  
125 mm | 160 mm | 200 mm

**ARIA**  
CONNECT

75 mm | 90 mm



**HEATPEX Sp. z o.o.**  
ul. Chrzanowskiego 11  
80-278 Gdańsk, Poland  
tel.: +48 661 693 697  
e-mail: sales@heatpex.pl

> **heatpex.pl**

This brochure, together with the information contained herein, is for informational purposes only and does not constitute an offer as defined in the provisions of the Civil Code. HEATPEX reserves the right to introduce content changes and without prior notice.



**ARIA CONNECT 75 mm / 90 mm design features 4**

**ARIA CONNECT system components 8**

Distribution box	8
Plenum box	9
Main central connector	10
Main side connector	11
Horizontal coupling	12
Vertical coupling	13
Ventilation duct with Ultra-Fresh® antibacterial additives	14
Silencer/damper	15
Supply/exhaust diffuser	16
Additional ARIA CONNECT accessories (available separately)	17

**Advantages of ARIA ADURO insulated mass flow ductwork for MVHR 18**

**ARIA ADURO system components 22**

**ARIA Planner Design Software 23**

**HEATPEX ARIA**

**ARIA CONNECT**  
MVHR air distribution ducting system

**+**

**ARIA ADURO**  
Insulated mass flow ductwork for MVHR



Discover all the advantages of MVHR air distribution ducting system

# ARIA CONNECT

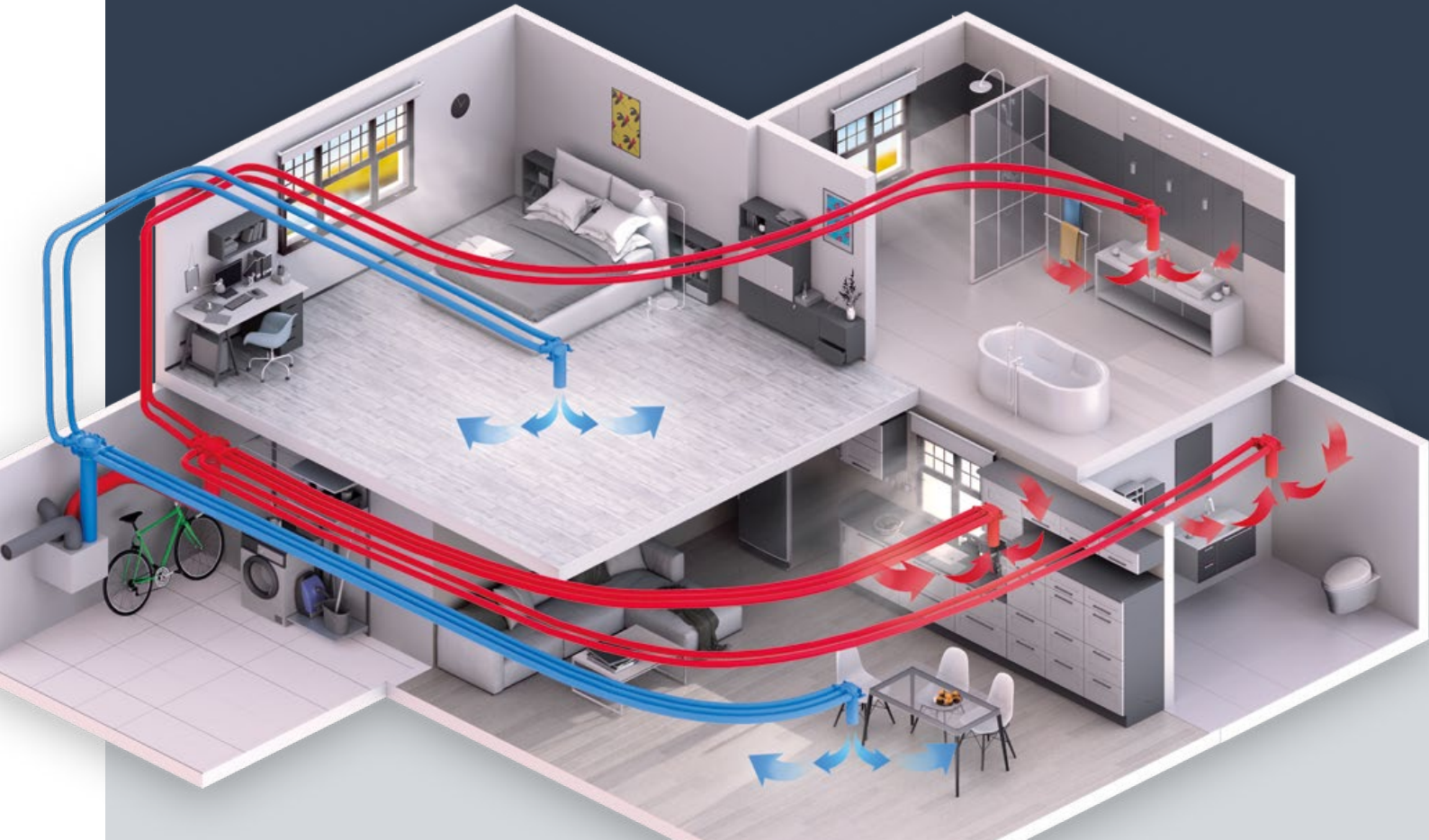

Complete air distribution system:

**only 6**  
basic elements

Boxes



Connectors



Couplings



Semi-rigid ventilation duct



## High flexibility

ARIA CONNECT with its **modular design** makes it easy to adjust to the specific requirements of any building. This helps to **reduce the number of parts** required to build the installation, **limit the space occupied by the ventilation system to a minimum** and to **keep the costs** of the entire project down.

Distribution **boxes can be joined horizontally or vertically**, increasing the number of connections needed.



### Vertical connection

System 75 mm – 20 sockets  
System 90 mm – 16 sockets

OR



### Horizontal connection

System 75 mm – 14 sockets  
System 90 mm – 12 sockets



## Installation faster than ever before

### OneClick® technology

OneClick technology® – original system of connections developed by HEATPEX – **all parts of the heat recovery system can be connected without the use of any tools.** If any modifications are needed during the installation, the different parts can also be easily disconnected, with no risk of damage.

## Highest airtightness level (ATC 1)

### Quiet and energy-efficient MHRV system

ARIA CONNECT air distribution system has the highest airtightness class **ATC 1 (according to EN 17192 standard)** due to its ingenious OneClick Technology and a choice of **high quality construction materials**.

The ATC 1 airtightness class replaces and surpasses the previous classification standards, making it **THREE times better than the old D class**. This is achieved **without any additional sealing material** during the installation works. The ATC 1 airtightness class has been **confirmed by tests** performed by an independent laboratory.



# ATC 1



## Antibacterial comes as standard

### Breathe fresh and clean air at all times

The entire ARIA CONNECT air distribution system is treated with the **Ultra-Fresh® antimicrobial additives to make it resistant to microbes (99.99% reduction)**. The antibacterial additives which include silver phosphate glass as its main ingredient are used by 300 global brands around the world. This has been **confirmed by independent lab tests** according to ISO 22196 standards.

The smooth inner surface of the air duct **keeps dirt deposits to a minimum**.

## Durability & strength

ARIA CONNECT is built from extremely **light yet durable plastic material** ensuring reliable operation for years, **without the risk of mechanical damage or corrosion**. It can be poured with concrete with **resistance to external pressure up to 500N**.

Construction materials used (PP – polypropylene) is considered safe as it poses **no health hazard** and is **100% recyclable**.



## Low-pressure loss

The careful design of every single part of the system and the **smooth inner surface of the pipes allows for keeping the low pressure loss**.



## Low noise level

The optimal airflow through different parts of the system and **double wall pipes helps to reduce the level of noise** generated by the flowing air, particularly **useful at night time**.

## Compact size



Only  
**9,5 cm**  
HEIGHT OF  
PLENUM  
BOX

Only  
**10,6 cm**  
HEIGHT OF  
DISTRIBUTION  
BOX

The small size of ARIA CONNECT makes it **possible to hide it in the ceiling**, either in the insulation layer covered with screed or **inside a suspended ceiling**.



# Distribution box

Distribution box with OneClick technology® is connected directly to the MHRV unit and used to supply fresh air into habitable rooms or extract used air from the „dirty” rooms.



## Main advantages

**Sockets with gaskets and rings in the OneClick® technology (10x75 mm or 8x90 mm in basic configuration)** allowing for quick and convenient installation of ventilation pipes.

**Modular construction** enables expansion with additional distribution boxes using horizontal (14x75 mm / 12x90mm sockets) and vertical connectors (20x75 mm/ 16x90 mm sockets).

**High mechanical resistance** thanks to the use of a specialized additive in the form of a plasticizer.

Designed to be connected to the main **central** connector or the main **side** connector.

ARIA MVHR system is the only one on the market with **the highest airtightness class – ATC 1** according to EN 17192, which guarantees **quiet operation and greater energy saving**.

SYSTEM	Length	Width	Height	Number of sockets	Material	Weight	Airtightness class	Catalogue number
75 mm	498 mm	360 mm	106 mm	10	PP	1,47 kg	ATC1	52300000100W
90 mm	522 mm	470 mm	106 mm	8	PP	1,85 kg	ATC1	52309000100W

\* The distribution box is delivered pre-assembled and aesthetically packaged.



# Plenum box

The plenum box with OneClick® technology is the element on which we mount supply / exhaust diffusers.



## Main advantages

**Adaptable mounting flaps with height adjustment.**

**Sockets with gaskets and rings in the OneClick® technology (3x75 mm or 2x90 mm)** allowing for quick and convenient installation of ventilation pipes.

**High mechanical resistance** thanks to the use of a specialized additive in the form of a plasticizer.

PLENUM BOX CAN BE FITTED IN THE FLOOR OR SUSPENDED CEILING



**Ribs for easy cutting.**

Smooth airflow adjustment thanks to a **dedicated damper.**

ARIA MVHR system is the only one on the market with **the highest airtightness class – ATC 1** according to EN 17192, which guarantees **quiet operation and greater energy saving.**

SYSTEM	Length	Width	Height	Diffuser connection diameter (internal)	75 connection height	125 mm pipe height	Material	Weight	Airtightness class	Catalogue number
75 mm	248 mm	315 mm	447 mm	125 mm	95 mm	349 mm	PP	0,75 kg	ATC1	52337500100W
90 mm	263 mm	315 mm	454 mm	125 mm	106 mm	349 mm	PP	0,78 kg	ATC1	52329000100W

\* Delivered factory assembled, complete with plugs and gaskets. Aesthetically packaged.

# Main central connector 125/160/200 mm

The connector is used to join the distribution box with supply or exhaust (insulated) pipes attached to the MVHR unit. It is installed in the central slot of the distribution box.



## Main advantages

**Fits both ventilation systems: 75 mm and 90 mm.**

The connector is **used to attach mass flow ducts (ARIA ADURO) for the transmission of large air flows to/from the heat recovery unit.** The connector's standard diameters make it **possible to also connect metal (SPIRO) or other ducts.**

The connector **allows for standard connections of pipe of 125, 160 and 200 mm diameter.** It comes equipped with high quality gaskets for all 3 dimensions.

Additionally you connect **150 mm and 180 mm pipes,** however they **require separate additional sealing.** **To minimise pressure losses,** during installation, the smaller unused connection diameters should be cut off.

**The connector has grooves** that facilitate cutting off the unnecessary part.

ARIA MVHR system is the only one on the market with **the highest airtightness class – ATC 1** according to EN 17192, which guarantees **quiet operation and greater energy saving.**

Height	Maximum diameter	Material	Weight	Airtightness class	Catalogue number
171 mm	249 mm	PP	0,29 kg	ATC1	52410900100W

# Main side connector 125/160 mm

The connector is used to join supply or exhaust (insulated) pipes to either side of the distribution box.

## CONNECTION SCHEME

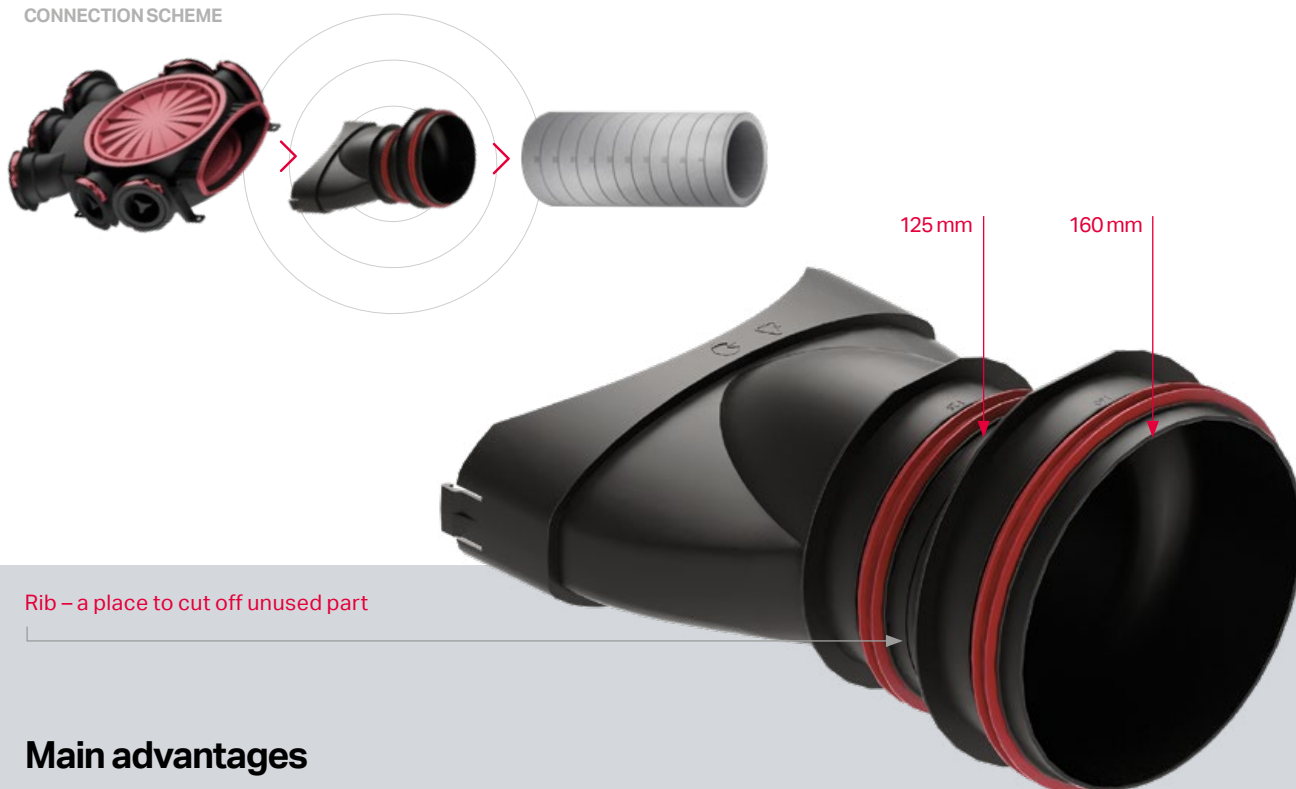

Rib – a place to cut off unused part

## Main advantages

**Fits both ventilation systems: 75 mm and 90 mm.**

**The connector is fixed to the oval slot on either side of the distribution box, replacing the 3x75 mm or 2x90 mm module.**

The connector is **used to attach mass flow ducts (ARIA ADURO) for the transmission of large air flows to/from the heat recovery unit.** The connector's standard diameters make it **possible to also connect metal (SPIRO) or other ducts.**

It allows for the connection of **125mm and 160mm pipes.** The connector is provided with gaskets for 125 and 160 mm diameters. Gaskets ensure a tight and rigid connection. **The connector has a groove** to facilitate the severance of 160 mm diameter, in case the 125mm is required. This is recommended in order to minimise pressure losses.

ARIA MVHR system is the only one on the market with **the highest airtightness class – ATC 1** according to EN 17192, which guarantees **quiet operation and greater energy saving.**

Length	Width	Height	Material	Weight	Airtightness class	Catalogue number
284 mm	216 mm	167 mm	PP	0,26 kg	ATC1	52411000100W

# Horizontal coupling

The horizontal coupling is used to connect two or more distribution boxes horizontally.



CONNECTION SCHEME



## Main advantages

Fits both ventilation systems: 75 mm and 90 mm.

The coupling plugs into the oval socket of the distribution box replacing the 3x75 mm or 2x90 mm module.

Connecting a second distribution box horizontally increases the **number of available sockets up to 14 (for 75 mm system) or up to 12 (for 90 mm system)**.

**The highest airtightness class – ATC1** according to EN 17192, ensures **quiet operation and greater energy efficiency**.

Length	Width	Height	Material	Weight	Airtightness class	Catalogue number
216 mm	110 mm	92 mm	PP	0,07 kg	ATC1	52411100100W

# Vertical coupling

A coupling for connecting two or more distribution boxes vertically.

## CONNECTION SCHEME



Brackets allows for  
easy installation



## Main advantages

**Fits both ventilation systems: 75 mm and 90 mm. The coupling plugs into the central slot of the distribution box.**

Connecting a second distribution box vertically increases the **number of available sockets up to 20 (for 75 mm system) or up to 16 (for 90 mm system).**

The coupling is equipped with **finger loops** for easy installation in the distribution box.

**The highest airtightness class – ATC1** according to EN 17192, ensures **quiet operation and greater energy efficiency.**

Diameter	Height	Material	Weight	Airtightness class	Catalogue number
249 mm	31 mm	PP	0,06 kg	ATC1	52411200100W

# Ventilation pipe with Ultra-Fresh® antibacterial additives

Semi-rigid corrugated pipe made of highest quality high-density polyethylene (PE-HD) with an outer diameter of 75 mm, 90 mm and 63 mm.

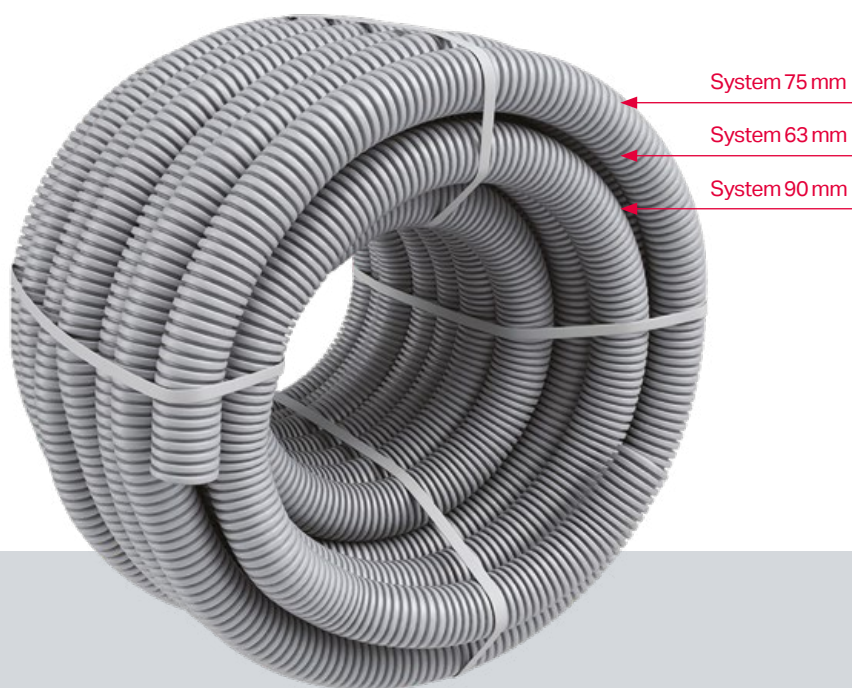
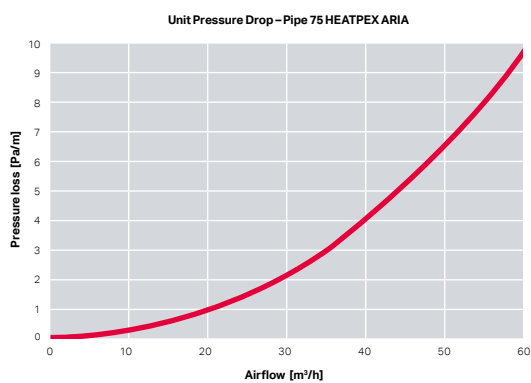

## Main advantages

All HEATPEX semi-rigid corrugated pipes are made with antibacterial additives (provided by Ultra-Fresh®) **ensuring 99,99% protection against microbes, bacteria, fungi etc.**

The antibacterial efficiency was **confirmed by laboratory tests** and the additives used pose **no health hazard**.

The pipe's **semi-rigid characteristic allows for easy routing of ventilation ducts** and **effortless adaptation to installation requirements**, without the need to use any tools, fittings or additional connectors.

The **smooth inner surface of the pipe reduces flow resistance to a minimum** and makes cleaning easier.

**High compressive strength of up to 500N** means the pipes **can be poured with concrete without the risk of mechanical damage**.

**Very good noise reduction** thanks to the double-walled pipe structure.

ARIA MVHR system is the only one on the market with **the highest airtightness class – ATC 1** according to EN 17192, which guarantees **quiet operation and greater energy saving**.

SYSTEM	Dimensions			Material	Weight	Airtightness class	Catalogue number
	Outer diameter	Inner diameter	Coil length				
63 mm	64 mm	52 mm	50 m	PE-HD	0,240 kg/m	ATC1	52006305000W
75 mm	76 mm	62,5 mm	50 m	PE-HD	0,273 kg/m	ATC1	52007505000W
90 mm	91 mm	75 mm	50 m	PE-HD	0,400 kg/m	ATC1	52009005000W

# Damper/silencer 125mm

Damper made of polyethylene helps adjust the ventilation system and effectively reduces noise.



## Main advantages

### Effective noise reduction.

**Stepless adjustment** of the airflow rate by turning the damper disc.

### Easy installation inside the plenum box.

**The highest airtightness class – ATC1** according to EN 17192, ensures **quiet operation and greater energy efficiency.**

Diameter A	Height B	Material	Weight	Airtightness class	Catalogue number
128 mm	50 mm	Polietylen	0,05 kg	ATC1	52002400100W

# Supply / exhaust diffusers



## Main advantages

Designed for installation **inside ARIA CONNECT plenum box.**

All diffusers come with an additional flange provided with a gasket which **maintains high level of tightness.**













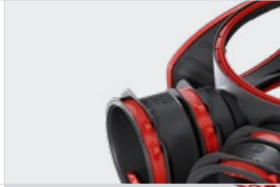



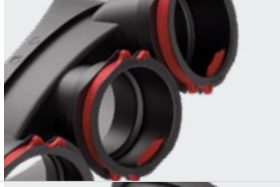

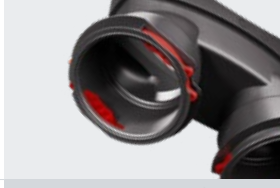
The supply diffuser has **additional PE insulation.**

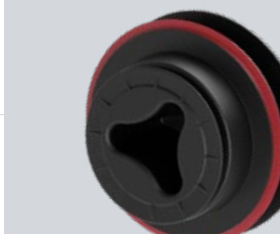
**Smooth air flow** adjustment by rotating air diffuser plate.

Diffuser type	Nominal diameter of the flange	Outer diameter	Height	Material	Weight	Catalogue number
Supply	125 mm	160 mm	60 mm	Stal	0,5 kg	52002100100W
Exhaust	125 mm	160 mm	60 mm	Stal	0,5 kg	52002200100W

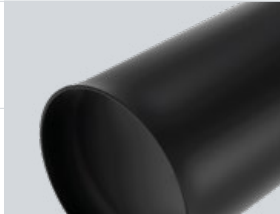

## ARIA CONNECT additional accessories (available separately)

	Name	Catalogue number	
	75 mm distribution box body	52410100100W	
	90 mm distribution box body	52413100100W	
	75 / 90 mm plenum box body	52410500100W	
	3 x 75 mm module for plenum box / distribution box	52410300100W	
	2 x 90 mm module for plenum box / distribution box	52413000100W	
	End plug 75 mm	52001000100W	
	End plug 90 mm	52413200100W	
	Distribution box cover – universal	52410400100W	
	Double-socket pipe connector for 75 mm system with a set of 2 gaskets	52011200100W	
	Double-socket pipe connector for 90 mm system with a set of 2 gaskets	52011500100W	
	Gasket 75 mm	52002000100M	
	Gasket 90 mm	52011400100M	
	Distribution box end plug – universal	52001100100W	

Discover all advantages of ARIA ADURO insulated mass flow ductwork for MVHR

ARIA ADURO

## High insulating properties

ARIA ADURO is made of a **lightweight and durable material with insulating properties** – foamed polystyrene with added graphite is biologically resistant to fungi, mould and bacteria. Both – the plastic and graphite added during production – **result in a significant increase in insulation ( $\lambda=0.029$  W/mK) compared to metal ducts insulated with wool**. Such high insulation minimizes heat loss and prevents condensation inside and outside the duct.

**$\lambda=0.029$**  (W/mK)

## Highest airtightness

The materials used, the patented **OneClick® connection system** and the design of the individual elements, allow the **highest airtightness class – ATC1 according to PN-EN-17192**, confirmed by tests performed by an independent laboratory. This means **3 times higher airtightness than systems with class D**. The high airtightness is also due to the design of the ARIA ADURO pipe – **a monorail made entirely of 1 element and a connector with a gasket**, which – thanks to its low profile – does not increase the diameter of the installation.



**ATC1** HIGHEST AIRTIGHTNESS CLASS



## Universal system

3 diameters: 125 mm / 160 mm / 200 mm

125  
mm

160  
mm

200  
mm

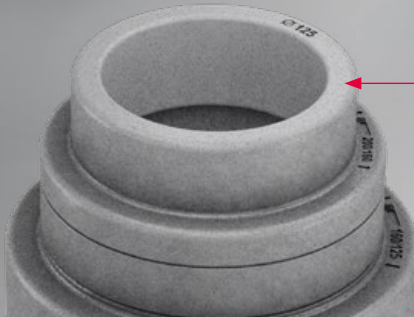

**Reducer**  
adjustable  
to all diameters



## Original mounting brackets for quick installation

**Quick installation** – simply attach the bracket to the surface, slide the pipe through and tighten the band.

**Modularity** – brackets, connected in series or in parallel, can be used for routing two or more ducts next to each other.

Ultra-light elements **require a minimum number** of mounting brackets.

**Versatility** – one size bracket for all 3 diameters.



5 cm

## Effortless cutting – simple setup

**Markers (every 5 cm)** help cut the pipe to required length. Wall thickness of only 17 mm lets you easily cut the pipe, using a simple knife.

2X

## faster installation

The ARIA ADURO system is **9 times lighter than a traditional ventilation duct based on metal pipes**, making it easier to installation to walls or suspension under the ceiling. Thus, the **installation is 2 times faster**.

2X

## lower airflow resistance

The durable, rigid material with a smooth walls guarantees **no risk of deformation during installation and reduces flow resistance twice as much as flexible hoses**, ensuring quiet and cheaper operation.

ONE<sup>®</sup>  
CLICK  
technology

## Proven solution: OneClick<sup>®</sup> technology

Thanks to the application of OneClick technology known from HEATPEX ARIA air distribution system, **connecting ARIA ADURO elements together is faster and easier than ever before**.

## ARIA ADURO system elements

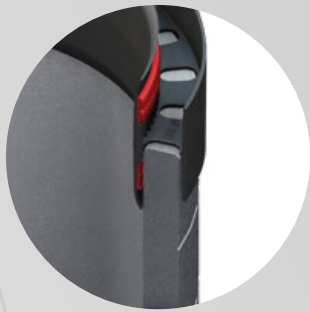

### Connector

Connector (gasket included) – a simple push-fit connection. **Connector low profile does not alter the overall installation diameter.**

Special openings **indicate secure connection.**



Mounting bracket with adjustable band clamp

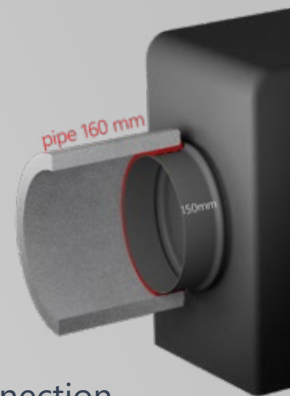

### Connection adapter

Intended for MHRV recovery units with 150 and 180 mm spigots.

**150 > 160**  
**180 > 200**

### Pipes

1-metre section, made entirely from **1 piece (monopipe)** – higher tightness and lower damage risk.

### Reducer

**Adjustable to all 3 diameters:**  
125/160/200 mm.

..... Bend 45°









..... Tee

## Complete MVHR system with standard dimensions

**ARIA ADURO is 100% compatible with HEATPEX ARIA air distribution semi-rigid ducting system.** ARIA ADURO fits to most heat recovery units available on the market, its dimensions coherent with traditional ventilation systems. Internal dimensions comply with EN 1506:2007 standards.



## Technical data: System elements

Name	Designation	Diameter		Length	Material	Airtightness class	Catalogue number
		inner	outer				
		mm	mm	mm			
<b>Pipe 1 m</b> 	ADR 125	125	159	1000	EPS	ATC1	52912500100T
	ADR160	160	194				52916000100T
	ADR 200	200	234				52920000100T
<b>Bend 45°</b> 	ADK 125	125	159	213	EPS	ATC1	52912590100T
	ADK160	160	194	226			52916090100T
	ADK 200	200	234	240			52920090100T
<b>Tee</b> 	ADT 125	125	159	380	EPS	ATC1	52912580100W
	ADT160	160	194				52916080100T
	ADT 200	200	234				52920080100T
<b>Damper</b> 	ADP 125	125	159	250	EPS, galvanized steel	ATC1	52912560100W
	ADP160	160	194				52916060100W
	ADP 200	200	234				52920060100W
<b>Connector</b> 	ADL 125	125		70	PP, EPDM	ATC1	52912570100W
	ADL160	160					52916070100W
	ADL 200	200					52920070100W
<b>Reducer</b> 	ADD 125/160/200	125/160/200		167	EPS	ATC1	52010200100T
<b>Mounting bracket</b> 	ADU 125/160/200	125/160/200		300	PP, nylon	ATC1	52010100100W
<b>NEW</b> <b>HRV unit connection adapter</b> 	AKR 150/160	150/160		40	EPDM	ATC1	52011600100T
	AKR 180/200	180/200		40	EPDM	ATC1	52011700100T

## Technical data: Accessories

Name	Designation	Diameter	Length	Material	Catalogue number
		mm	mm		
<b>Duct silencer</b> 	BL 125	125	1000	Aluminum-polyester jacket, galvanized steel, EPDM gaskets, glass wool insulation	52010300100T
	BL160	160			52010400100T
	BL 200	200			52010500100T
<b>Air intake / outlet grille - hooded</b> 	AN 125	125	-	Stainless steel	52010600100T
	AN160	160			52010700100T
	AN 200	200			52010800100T
<b>Air intake / outlet grille - flat</b> 	KA 125	125	-	Stainless steel	52010900100T
	KA160	160			52011000100T
	KA 200	200			52011100100T

# ARIA Planner



 **Design a heat recovery system in 10 minutes!**

**ARIA PLANNER – selection software, an easy tool that creates a bill of materials needed for each HRV project.**

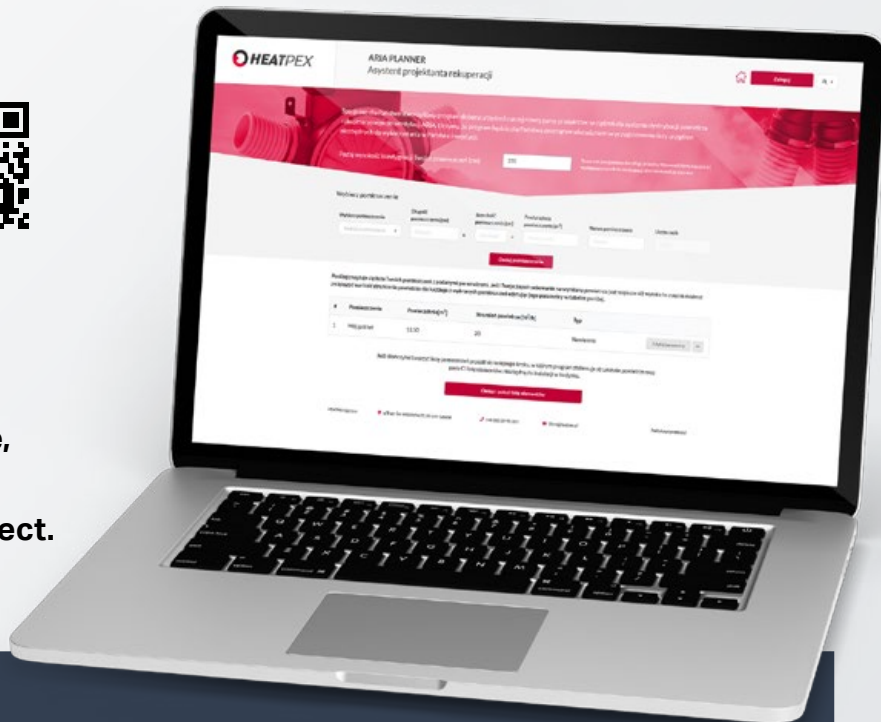

## 3 SIMPLE STEPS

### STEP 1

**Enter the list of rooms from your floorplan**

ARIA PLANNER will **automatically select the size of the heat recovery unit and required air flows** depending on room type and number of occupants.

It will then **create air flow balance** for a harmonised supply and exhaust ventilation system.

ARIA PLANNER will also **determine the number of supply and exhaust points (diffusers) for each room** and calculate the number of required ventilation ducts.



### STEP 2

**Choose the type of connection to heat recovery unit – SIDE or CENTRAL**

**You will receive a list** of components and air supply requirements, all tailored to your home design

Lista materiałów

Numer katalogowy	Nazwa	Liczba [sztuka]	Cena netto [PLN/szt.]	Wartość netto [PLN]
103 375 001	Skrzynka rozprężna	15	104,82	1572,30
100 022 001	Aneksostat wywiewny 125	8	38,92	311,36
100 021 001	Aneksostat nawiewny 125	7	41,95	293,65
100 075 000	Kura ARIA 75 - 20m	8	375,00	3000,00

Cena wyliczona

### STEP 3

**Save and download your design**



The design **contains calculated air flows, a bill of materials tailored to the selected configuration** as well as **guidelines on installation of the heat recovery system**. The document will indicate where and how to install diffusers, how to route ventilation ducts, and where to place the air intake and exhaust outlets.\*

ARIA PLANNER IS AVAILABLE ON OUR WEBSITE [www.heatpex.pl](http://www.heatpex.pl)

\* Full access to ARIA PLANNER is available for logged in users only

Complete product range available on [heatpex.pl](http://heatpex.pl)



**ONE**<sup>®</sup>  
**CLICK**  
**technology**



**99%** ANTIBACTERIAL  
PROTECTION



**ATC1** TOP AIRTIGHTNESS  
CLASS



100% RECYCLABLE



Download  
the catalogue

See how to work with the  
**OneClick® technology**



> [heatpex.pl](https://heatpex.pl)